



**YOUR
OUTDOOR
COOKING
ADVENTURE**

WWW.RHINO-PODS.COM





WEATHER, WATER, CHEMICAL AND UV RESISTANT

Our pods are made of extraordinarily tough stuff. This amazing material can be washed, even jet washed. It is chemical resistant and weighs far less than plywood or other materials yet is also heat resistant to 150 degrees Celsius (in real terms it is fine to stand boiling hot pans on).



BUILT TO LAST

Using high quality materials and stainless steel fittings, your kitchen is built to last. Made in Italy and the UK, means easy lifetime access to spare parts and support. Plus we give a lifetime guarantee that we will replace any defective parts free of charge for the lifetime of the product

Rhino-Pods are made from a unique, extraordinarily durable, material which won't split, swell or splinter. They are suitable for extended outdoor use.



OUR CLICK-LOCK SYSTEM

Our unique and exclusive click-lock system means that we can offer pods that can be easily dismantled and reassembled without tools. Yet they are also strong and firm. When they 'lock' into position they make the pod strong and stable. They will last a lifetime – and we guarantee that as they have been tested up to 40,000 times.

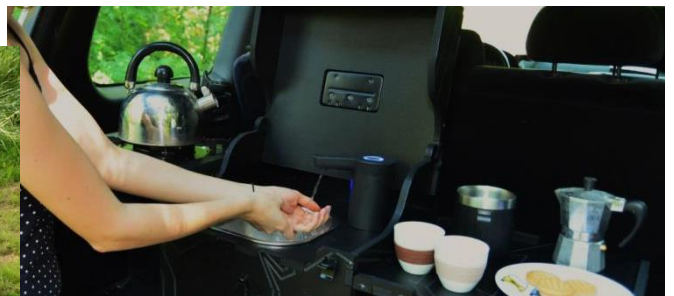

THE CUBIT POD

RHINO-PODS



Small, light and easy-to-carry, the highly portable Cubit kitchen is perfect for tailgating, van life, camping, work vans, RVs, truckers, remote work places and outdoor adventures. Functional and flexible, with integrated sink, self-powered tap, chopping board and integrated 5L water and waste containers. The side tables give space for two generic stoves, plus the fold back lid gives you additional space. It's folding handle makes this totally independent kitchen easily portable. Set up whenever you want, wherever you want.



Included with your pod:

- Stainless steel sink
- Polypropylene chopping board that fits in the sink
- Cordless rechargeable tap
- Matching 5L water and waste bottles



Using high quality materials and predominantly stainless steel fittings, your Cubit is built to last. Made in Italy, this means easy lifetime access to spare parts and support.



STRONG



MULTIFUNCTIONAL

Weighing only 15kg and extraordinarily compact, with a sturdy integrated carry handle you can take your Cubit anywhere you want.



Your Cubit is made from a durable, unique and extraordinary material. Easily resistant to weather, heat, chemicals and is easy to clean. It can even be jet washed!



MEASUREMENTS



Easily portable, lightweight, strong material weighing just 15kg

kg

Strong design – can hold up to 100kg!



Inside of the lid: 36cm x 30cm
Side tables: 34cm x 24cm
Sink size: 20cm x 20cm x 10cm

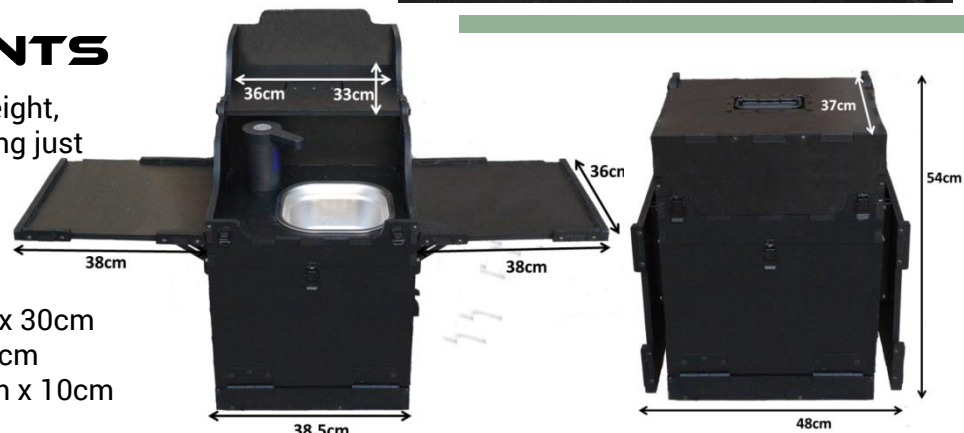

PORTABLE

Your pod is easily portable with its carry handle, and weighing only 15kg



Cordless, fast flow, rechargeable tap

Chopping board that fits in the sink



Stainless steel sink
20cm x 20cm x 10cm
(8in x 8in x 4in)

MULTIFUNCTIONAL LID

Your lid can be closed, upright and backward as a rear shelf. Use it as cover, wind protection or as an extra space – even put your stove and cook on it!



THE MATERIAL

Your pod is Weatherproof, waterproof, resistant up to 150°C, and easy to clean



STORAGE SPACE

Space inside for a burner and other cooking accessories



SIDE TABLES

Two flip up side tables that easily fit single stoves



CLICK-LOCK DESIGN

To secure the side tables down to make your pod rattle free

LEGS

Fold-down legs so you can use your pod at sitting and standing height



SECURE DOWN YOUR POD

Holes in the front, back and in the bottom panel for securing down



INTEGRATED WATER SYSTEM

Matching 5L water and waste bottles connected by water and waste pipes. Just fill up and go!



Weather and waterproof



Resistant up to 150°C



Weighs only 15kg



Easy to clean



Strong tap flow at 0.5L/min

THE MANTA POD

RHINO-PODS

Designed to fit most hatchbacks for roof tenters, tent campers and other adventurers that want to be able to cook, prep or wash from their car. Designed with three work areas, quality locking slides, storage underneath, and built in wind protection, it is small enough for almost all hatchback cars on the market.



Weighs only 12kg



Weather and waterproof



Easy to clean



Resistant up to 150°C



SMALL AND LIGHT

Using high quality materials and stainless steel fittings, your Manta is built to last.

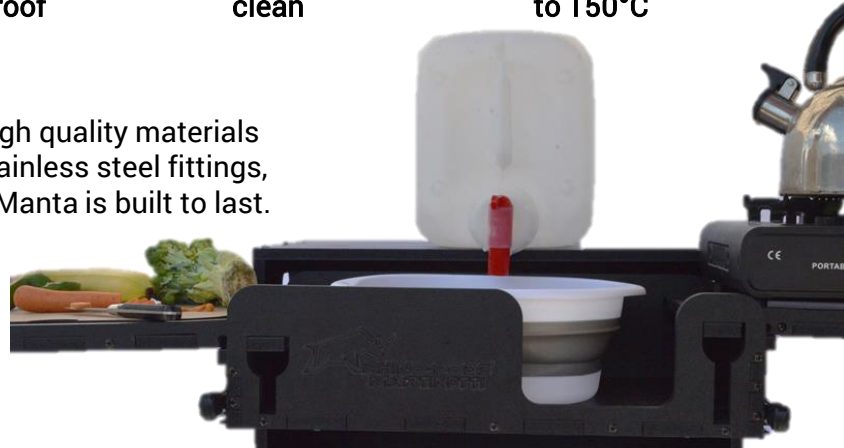

BUILT TO LAST

We will replace any defective parts for the lifetime of the product, supply any spare parts you need, and give lifetime customer support.

Your Manta Pod is resistant to water, chemicals, weather and is easy to clean. Made from a durable and unique material with strong slides.

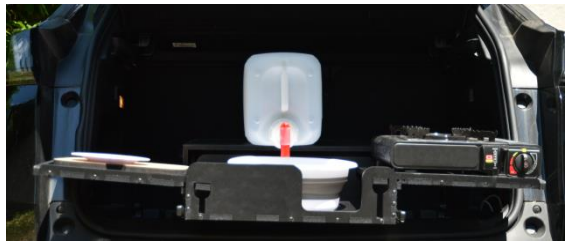

STRONG



Thanks to our unique design, the pod is only D 50cm x W 53cm x H 28cm and weighs just 12kg



LIFETIME GUARANTEE

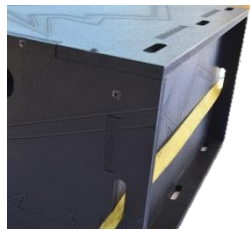

STRAP HOLES

Strap holes trough the back to make it easy to tie down the pod when being used in the car.

Integrated carry handles

ROTATING HINGES FOR THE SIDE TABLES

Makes quick and easy to open and close, with the added option of leaving the side tables upright to act as wind protection.



THE MATERIAL

Your pod is Weatherproof, waterproof, resistant up to 150°C, and easy to clean



Three work areas, all with space for preparation, cooking and generic burners

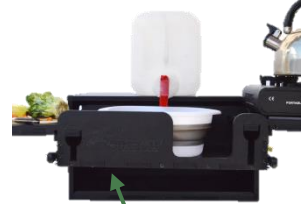

The tiered level means you can use the central work area with a burner or with a bottle and a foldable sink



QUALITY LOCKING SLIDING HINGES

Compact but pulls out to become usable area with fold out tables to become an useful cooking and preparation area



STORAGE SPACE

The high mounted slides are designed to clear the boot lip of most cars, the space created also allows the storage of burners, pots, pans and other accessories.

MEASUREMENTS



Lightweight, strong material weighing just 12kg

kg

Strong design – can hold up to 100kg!

Height, width and depth 28cm x 53cm x 50cm

Side tables 28cm x 35cm

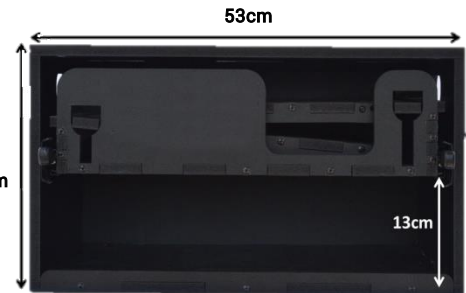
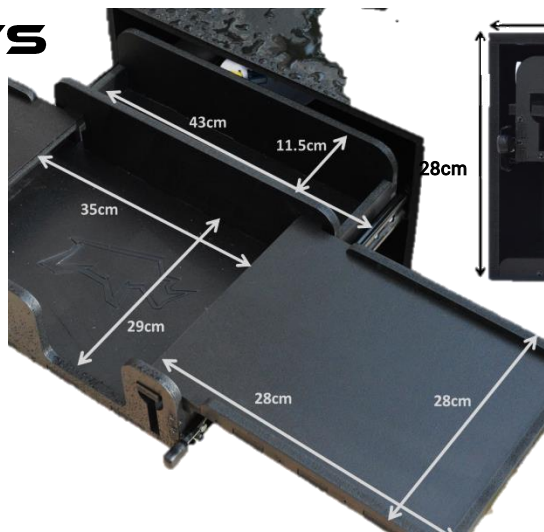

THE TAVO POD

RHINO-PODS

The Tavo Pod is a multifunctional compact portable outdoor camping kitchen. It features a collapsible sink, self-powered tap, cutting board and storage space. Thanks to the fold-out legs integrated in the lid, it has multiple purpose either used to raise the height of the pod or as table, or as a seat. Lightweight and portable, this pod adapts to any need and environment, perfect for all adventures.



Using high quality materials and stainless steel fittings, your Tavo is built to last.



Included with your pod:

- Foldable plastic sink
- Polypropylene chopping board/wind cover
- Cordless rechargeable tap
- Flip down legs in the lid

Your Tavo Pod is light yet hard wearing and robust for a lifetime of use. We will replace any defective parts for the lifetime of the product, supply any spare parts you need, and give lifetime customer support.



Easy to clean



Weighs only 16kg



Resistant up to 150°C



Weather and waterproof



Strong tap flow at 0.5L/min



With its sturdy and firm build, bottom, and design, you can use your Tavo pod anywhere you'd like and on any terrain,

MEASUREMENTS



Lightweight, strong material your pod weighs just 16kg

kg

Strong design – can hold up to 100kg!

Height, width and depth
42.5cm x 52cm x 40cm

Side tables
35cm x 38cm





TWO PANELS FOR WIND PROTECTION.

The right side table sits upright to become a RH wind cover, and the side table chopping board cover' can be utilised to the rear or LH side



Three work areas, all with space for preparation, cooking and generic burners

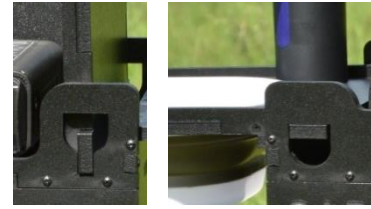

ROTATING HINGES FOR SIDE TABLES,

Quick and easy to open and close, with the added option of leaving the side tables upright to act as wind protection.

Multifunctional chopping board/wind cover

Cordless, fast flow, rechargeable tap



CHOPPING BOARD OR WIND COVER

Chopping board which fits into the sink hole and over the tap pucks to create a flat surface to use

Foldable plastic sink that can be stored inside



THE MATERIAL

Your pod is Weatherproof, waterproof, resistant up to 150°C, and easy to clean



Integrated carry handles



STORAGE INSIDE

Storage space inside for the collapsible sink, tap, bottle, burner and other accessories

COMPACT, FLIP DOWN LEGS IN THE LID

They create a stand/seal/table which can be used to raise the pod or sat on while using the pod

CLOSED

LID OFF

STOOL OPEN

OPEN



THE CUCININO POD

RHINO-PODS

A complete good sized outdoor kitchen with a deep stainless steel sink, self powered tap, 10L water and waste bottles. It has internal storage, a storage drawer, a chopping board, preparation area, and draining area. Sturdy and stable, yet easy to assemble and dismantle for storage thanks to our 'click-lock' system. This collapsible, complete kitchen is perfect for camping, van living, van conversions or as an outdoor kitchen at home. The Cucinino pod has three distinct work areas with room for a generic burner on each side table, plus the fold back lid gives you additional space that fits most double burners.

Using high quality materials and mostly stainless steel fittings, your kitchen is built to last. Made in Italy and the UK, means easy lifetime access to spare parts and support.



STRONG

Included with your pod:

- Stainless steel sink
- A chopping board that fits in the sink
- Cordless rechargeable tap
- Matching 10L water and waste bottles
- Internal storage drawer



BUILT TO LAST



FLEXIBLE

With its sturdy and firm build, bottom, and design, you can use your sink pod anywhere you'd like and on any terrain

STURDY AND STABLE



Easy to clean



Resistant up to 150°C



Weather and waterproof



Strong tap flow at 0.5L/min

WEIGHING 25KG

Your kitchen is light yet hard wearing and robust for a lifetime of use with our lifetime guarantee

MEASUREMENTS

Inside of the lid:
64.5cm x 42cm

Side tables:
36cm x 38cm

Sink size:
32cm x 26cm x 15cm



THE MATERIAL

Your pod is Weatherproof, waterproof, resistant up to 150°C, and easy to clean



32cm x 26cm x 15cm
Stainless steel sink

MULTIFUNCTIONAL LID

Your lid can be closed, upright and backward as a rear shelf. Use it as cover, wind protection or as an extra space – even put your burner and cook on it!



INTERNAL DRAWER

Perfect space for storage of smaller items



Chopping board that fits in the sink

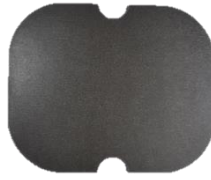

Cordless rechargeable tap

Integrated carry handles

STORAGE SPACE

Space inside for a burner and other cooking accessories

SIDE TABLES

Two flip up side tables that easily fit single generic burners



Matching 10L water and waste bottles plus water and waste pipes

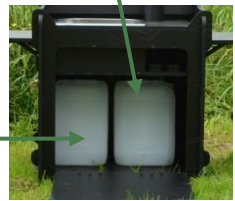

LEGS

Fold-down legs so you can use your pod at sitting and standing height



CLICK-LOCK DESIGN

Made to secure the side tables down and to take apart the panels for easy assembly and disassembly



CAN BE EASILY DISASSEMBLED AND ASSEMBLED

Thanks to our unique integrated 'click-lock' system – no screws or bolts to struggle with or lose. Plus the stainless sink is encapsulated to ensure it doesn't get damaged during storage.

SECURE DOWN YOUR POD

Holes in the bottom and side panels for pegs and straps



CAN BE ASSEMBLED IN UNDER 5 MINUTES!

THE CAMBIO POD

RHINO-PODS

A collapsible camping kitchen designed with two internal shelves to fit gas bottles, burners and accessories. Perfect for camping as your outdoor kitchen, as a removable kitchen in your van, next to your barbeque, for any outdoor adventure, or even as a back-up kitchen. With two shelves to store gas bottles, stoves and accessories The Cambio Pod has space for two generic burners and areas for preparation and cooking.



STRONG

Using high quality materials and mostly stainless steel fittings, your kitchen is built to last. Made in Italy and the UK, means easy lifetime access to spare parts and support.



BUILT TO LAST



WEIGHING JUST 18KG



Resistant up to 150°C



Weights only 18kg



Easy to clean

With room for up to 3 generic gas stoves, this is truly a kitchen you can set up whenever and wherever you want to prepare and cook.



Weather and waterproof



FLEXIBLE

MEASUREMENTS

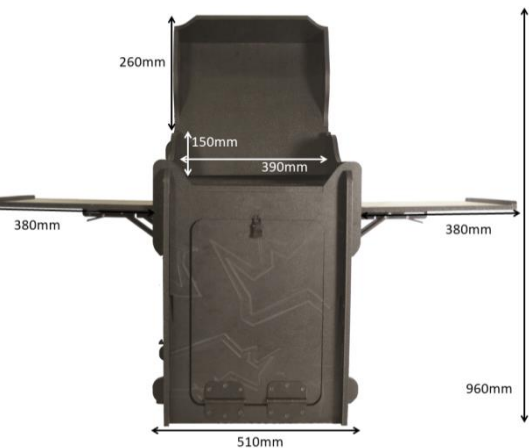

With its sturdy and firm build, bottom, and design, you can use your sink pod anywhere you'd like and on any terrain.



STURDY AND STABLE

Inside of the lid:
64.5cm x 42cm
Side tables:
36cm x 38cm

Strong design – can hold up to 100kg!

Lightweight, strong material your pod weighs just 18kg



kg

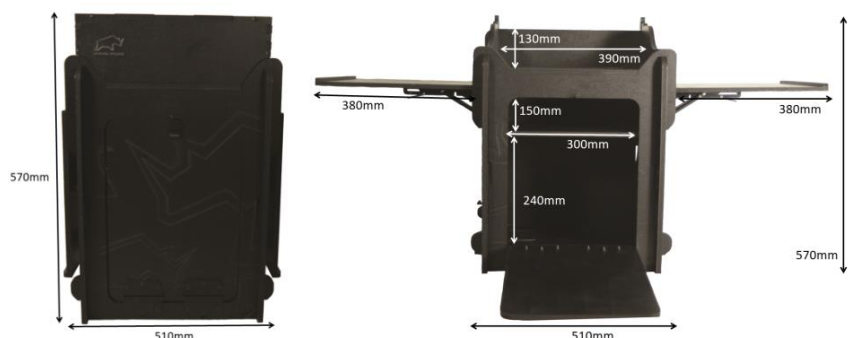

THE MATERIAL

Your pod is Weatherproof, waterproof, resistant up to 150°C, and easy to clean



BURNER STORAGE

Space on the main surface to permanently store a burner



MULTIFUNCTIONAL LID

Your lid can be closed, upright and backward as a rear shelf. Use it as cover, wind protection or as an extra space – even put your burner and cook on it!



CLICK-LOCK DESIGN

Made to secure the side tables down and to take apart the panels for easy assembly and disassembly

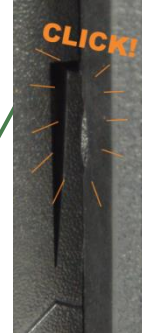

- TESTED TO 40,000 OPERATIONS
- QUICK AND EASY ONE FINGER OPERATION
- UNIQUE PATENT PENDING DESIGN
- NO NUTS OR BOLTS TO LOSE
- STRONG, STABLE AND SECURE



SIDE TABLES

Two flip up side tables that easily fit single generic burners

LEGS

Fold-down legs so you can use your pod at sitting and standing height



SECURE DOWN YOUR POD

Holes in the front, back and in the bottom panel for securing down

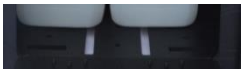

STORAGE INSIDE

Storage space inside on the two internal shelves for accessories and space to store a single burner on the top shelf.



CAN BE EASILY ASSEMBLED AND DISASSEMBLED

Thanks to our unique integrated 'click-lock' system – no screws or bolts to struggle with or lose.

CAN BE ASSEMBLED IN UNDER 5 MINUTES!



Integrated carry handles

FRONT DOOR

Your front door secured by catches to keep your accessories secure and rattle free on your adventures

THE CHUCK POD

RHINO-PODS



**BUILT
TO
LAST**

Your kitchen is light yet hard wearing and robust for a lifetime of use with our lifetime guarantee



FLEXIBLE

Using high quality materials and mostly stainless steel fittings, your kitchen is built to last. Made in Italy and the UK, means easy lifetime access to spare parts and support.



STRONG

With room for up to 3 generic gas stoves, this is truly a kitchen you can set up whenever and wherever you want to prepare and cook.

With its sturdy and firm build, bottom, and design, you can use your chuck pod anywhere you'd like and on any terrain,



**STURDY
AND
STABLE**



Weighs only 20kg



Easy to clean



Weather and waterproof



Resistant up to 150°C

MEASUREMENTS



Lightweight, strong material your pod weighs just 20kg

kg

Strong design – can hold up to 100kg!

Height, width and depth 52cm x 50cm x 42cm

Side tables 32 cm x 36 cm



THREE PANELS FOR WIND PROTECTION.

The side tables can sit upright along with the back lid to become wind covers for those windy days you cant to cook hassle free.



MULTIFUNCTIONAL LID

Your lid can be closed, upright and backward as a rear shelf. It can also be removed entirely.

Use it as cover, wind protection or as an extra space – even put you burner and cook on it!

THE MATERIAL

Your pod is Weatherproof, waterproof, resistant up to 150°C, and easy to clean



Integrated carry handles



ROTATING HINGES FOR THE SIDE TABLES,

Quick and easy to open and close, with the added option of leaving the side tables upright to act as wind protection.



REMOVABLE FRONT DOOR

Removable front door so you can easily access your drawers and accessories

LEGS

Fold-down legs so you can use your pod at sitting and standing height



STORAGE INSIDE

Storage space inside the two Drawers and space to store any single burner and larger accessories in the space below.



QUALITY SLIDING DRAWERS

Compact but useful, two drawers that pull out. One small and one large so you can store and access all your necessities easily.



CLOSED



OPEN



LEGS OPEN



WHO ARE WE?

We love the outdoors and especially dining alfresco. Casual relaxed time dining in nature with friends and family has made some of the best memories for us.



When we talk about dining outdoors the word "alfresco" really describes the delights outdoor dining provides, it captures the essence of enjoying the outdoors and the natural environment. Whether that is at the beach, on a trail, hiking, fishing, climbing, biking, walking or just in your backyard or garden.

We wanted a way to get away when the thought occurred. We wanted to get ready in an instant so we could get up and go at a moment's notice before the impetus was lost.

We realised that the effort to plan, gather, setup and prepare for your alfresco adventure was all too often the barrier to realising and enjoying your next alfresco adventure.

Rhino was made to help!

Rhino helps realise the alfresco adventure. Kitchen pods that are ready to go whenever the outdoors calls. Keep them stocked with basics so that you just have to load up and go. This really is cooking for adventure

Life should be an adventure – best start the adventure now!

We are a small family business, hands on for everything from design to manufacture; we even do our own photography and artwork. We test every pod prototype ourselves and check the designs 'in the field' to make sure everything works the way it should do.

The attention to detail means that we can sell with confidence. It's not just a fancy 3D rendered image – we make real prototypes, test and modify them ourselves to make sure that you have the most hassle free and fun alfresco time outdoors.

Really good designs - that really work.

The beauty of nature is all around us. Join us, leave the hustle and bustle and spend time on an alfresco adventure with a Rhino Pod and realise what is important in life. Make great alfresco memories whether alone, with a partner or friends and family.

Rhino- Cooking for Adventure



CONTACT US

Email: info@rhino-pods.com

Web: www.rhino-pods.com